

55. Tire Pressure Monitoring System

A: WIRING DIAGRAM

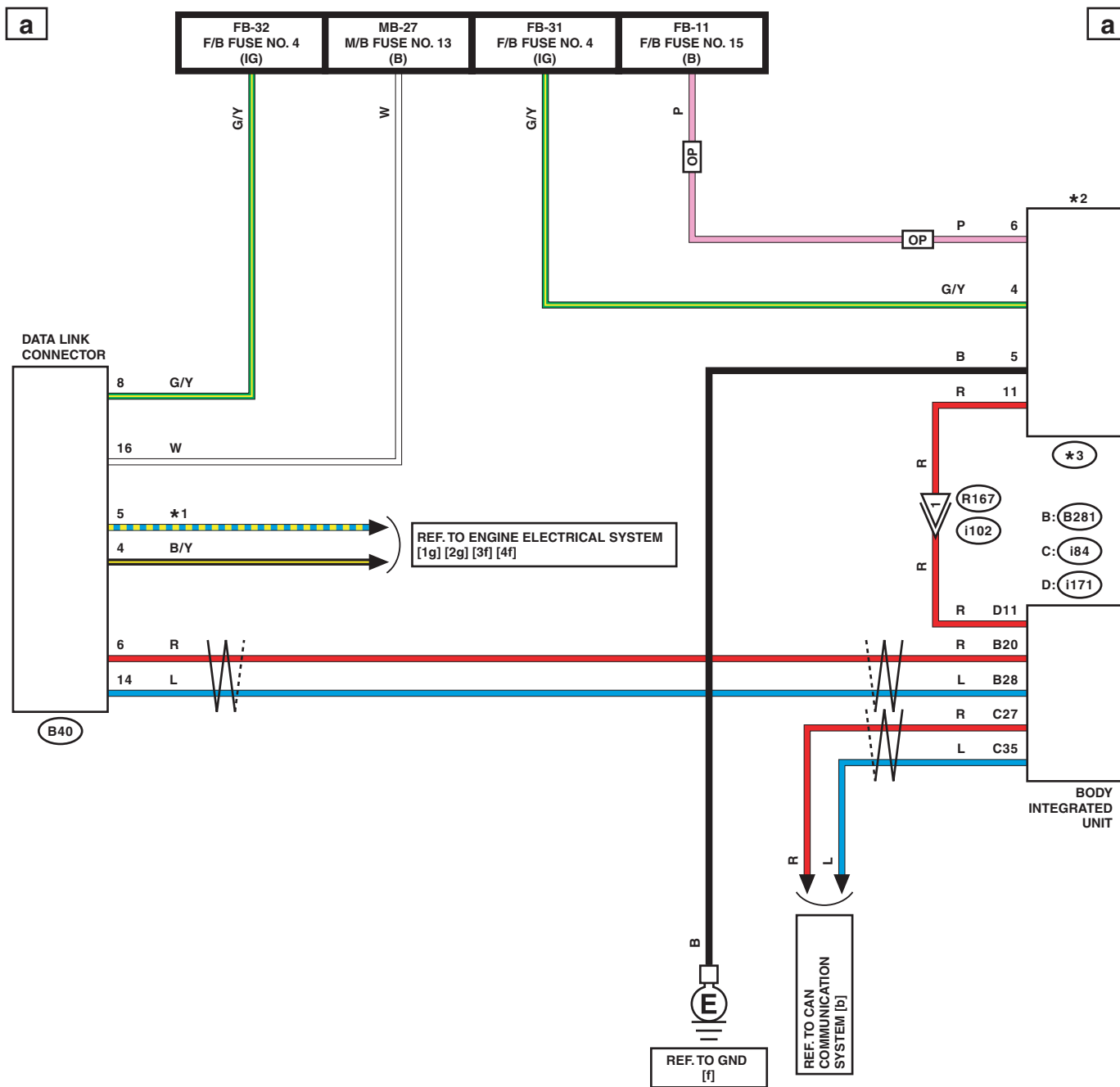

OP : WITHOUT PUSH BUTTON START

***1** : ENGINE TYPE FA : B/R
ENGINE TYPE EJ : B/W

***2** : WITHOUT PUSH BUTTON START : TPMS & KEYLESS ENTRY CM
WITH PUSH BUTTON START : TPMS CM

***3** : WITHOUT PUSH BUTTON START : R221
WITH PUSH BUTTON START : R211

WI-44593

Tire Pressure Monitoring System

WIRING SYSTEM

b

b

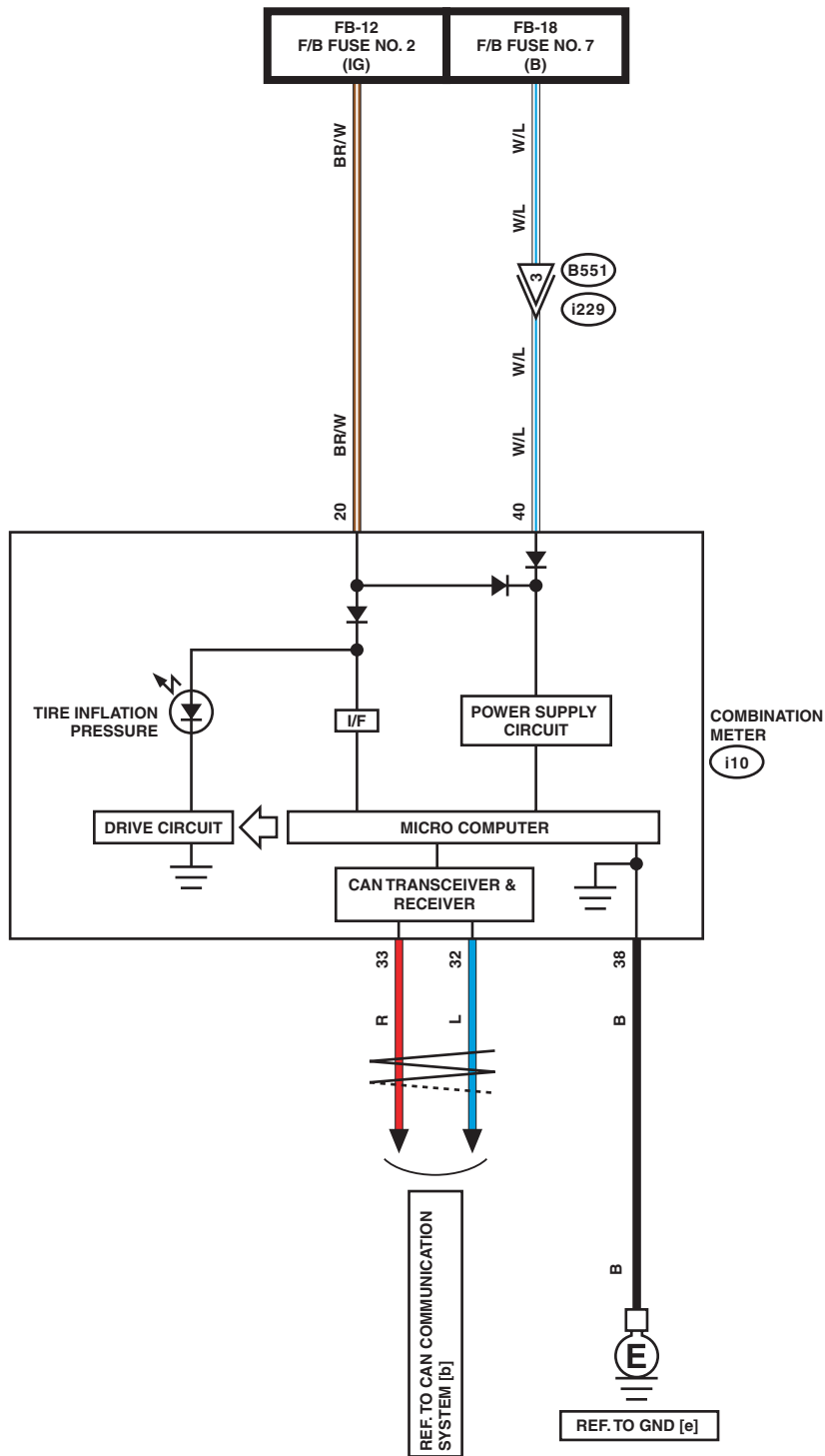

WI-44594

C

C

LIST OF CONNECTORS

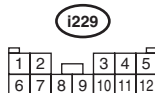
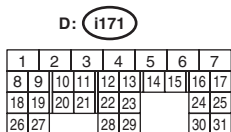
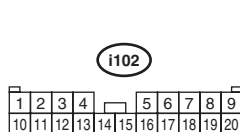
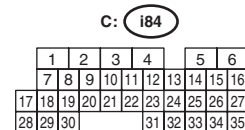
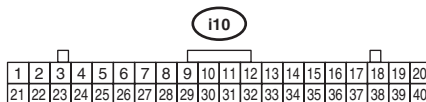
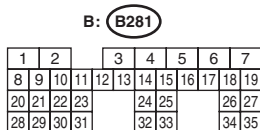
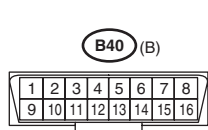

OP : R211

WP : R221



OP : WITHOUT PUSH BUTTON START

WP : WITH PUSH BUTTON START